

## Pandora would like to thank you for choosing our service-security system

### **Pandora Mini v2 is a car service-security system, built for cars with on-board voltage of 12V.**

It is a complex engineering product, which includes unique and modern software and hardware solutions. When building the Pandora Mini we were using the most up-to-date electronics from world's best manufacturers. The device is built using high-precision mounting and control machinery, thus we guarantee highest possible quality, reliability and stable technical characteristics for the whole operation period.

Elegant and advanced technical design and unique ergonomic interaction algorithms that are used in the Pandora Mini allow enhancing your car with fantastic set of intuitive and useful functions.



**WARNING!** IT IS STRONGLY ADVISED TO HAVE PROFESSIONAL CAR MECHANIC INSTALLING THE SYSTEM. ANY CAR ELECTRONICS INSTALLER SHOULD BE ABLE TO INSTALL THE PANDORA MINI V2 USING INSTALLATION SCHEME IN THIS MANUAL AND ALARM STUDIO SOFTWARE. MOST FEATURES ARE HIGHLY DEPENDENT ON COMPETENT INSTALLATION. OUR SYSTEMS ARE THOROUGHLY TESTED FOR QUALITY, SO IF A FEATURE FAILS TO PRODUCE EXPECTED RESULT, MOST LIKELY THE PROBLEM IS IN IMPROPER INSTALLATION.

---

This device has limited external factors resistance. It should not be subjected to water beyond occasional splatter, or operated in temperatures outside  $-40^{\circ}$  to  $+80^{\circ}$  C range.

Our web site: [www.pandorainfo.com](http://www.pandorainfo.com)  
Customer support: [support@pandorainfo.com](mailto:support@pandorainfo.com)

Product is in conformity with Electromagnetic Compatibility  
Directive EMC 2004/108/EC and R&TTE Directive 1999/5/EC



## Table of contents

<b>System set</b>	<b>4</b>
<b>System features</b>	<b>5</b>
Base unit	5
Control and monitoring	5
Arming mode	7
Multi-button code immobilizer	8
Immobilizer mode	8
Anti-Hi-Jack mode	8
Anti-Hi-Jack2 mode	9
<b>Immobilizer radio tag</b>	<b>9</b>
Replacing an immobilizer tag battery	9
<b>Mobile applications</b>	<b>11</b>
<b>Control over the system</b>	<b>13</b>
Arming	13
Disarming	14
<b>Service (valet) mode</b>	<b>16</b>
<b>Control over the system in case of emergency</b>	<b>17</b>
Emergency disabling immobilizer radio tags	18
<b>System installation</b>	<b>20</b>
General installation requirements	20
Wiring description	21
Wiring diagram	22
<b>System configuration and programming</b>	<b>25</b>
Entering the programming mode	25
Exiting the programming mode	25
Pandora Alarm Studio	26
Programming menu	27

<b>Additional information</b>	<b>35</b>
Siren sounds and light signalizations	35
Beeper sound signals	35
Meaning of the LED indicator colors	36
Checking the number of recorded radio tags	36
Additional devices	37
System module layout	39
<b>Warranty obligations</b>	<b>40</b>
Installation certificate	43
Acceptance certificate	44
Warranty card	44

## System set

Base unit	1
Immobilizer tag	2
Blocking relay	1
Cable with VALET button	1
User installation manual	1
Personal owner's card	1
Beeper (compact sound emitter)	1
Main cable	1
Fastening kit	1
Packaging	1

---

MANUFACTURER RESERVES THE RIGHT TO CHANGE SET AND CONSTRUCTION OF THE PRODUCT TO IMPROVE ITS TECHNOLOGICAL AND OPERATIONAL PARAMETERS WITHOUT NOTIFICATION.

---

## SYSTEM FEATURES

### Base unit

- Integrated 2.4 GHz module with support of Bluetooth 4.2 Low Energy protocol
- Built-in integral accelerometer for determining motion/shock/tilt with adaptive processing algorithm and sensitivity controls
- Built-in micro-USB port
- Integrated temperature sensor (interior temperature)
- Dialog coding of control commands with 128-bit encryption keys (a key is changed each time an additional device is recorded)
- Individual "Secret PIN-code", changeable "Service PIN-code" and "Immobilizer PIN-code"

### Control and monitoring

Control of the vehicles zones depends on the type of connection and system settings, original car operation and trim.

Analog connection – It is a direct connection of analog inputs and outputs to electrical circuits of a vehicle in accordance with a connection diagram.

Digital connection – It is a connection to digital (CAN, LIN) buses. It allows reading information (statuses) and controlling vehicles (commands) by digital buses of the vehicles. The detailed information about digital protocols is available on [loader.pandorainfo.com](http://loader.pandorainfo.com). The declared statuses may not be available for certain vehicle trims.

Built-in sensors – These sensors are integrated in the base unit. The sensors perform control and protection of the vehicle. Additional connections are not required

Additional sensor (\*optional) – External additional sensors are connected to the base unit.

Analog connection	Digital connection	Built-in sensors	Additional sensors	Guarded and monitored zones
	•	•	*•	Interior temperature (status)
	•		*•	Engine temperature (status)
	•		*•	Outside sensor (status)
		•		Voltage of the on-board circuits (status, security zone – alarm level)
		•		Shock sensor (security zone – alarm and warning level)
		•		Motion sensor (security zone – alarm level)
		•		Tilt sensor (security zone – alarm level)
	•		*•	OE alarm system status via CAN, additional sensor, (status, security zone – alarm and warning level)
•	•			Turning ignition on (status, security zone – alarm level)
•	•			Opening doors, separate indication for each door via CAN (status, security zone – alarm level)
•	•			Opening a trunk (status, security zone – alarm level)
•	•			Pressing brake (status, security zone – alarm level)
•	•			Engine operation control - RPM (status)
•	•			Position of a gearbox selector/handbrake(status)
	•			"Parking light is not turned off" notification
<b>Control (Commands)</b>				
•	•			Central lock
	•			Car original alarm system
•	•			Trunk
•	•			Turn lights
•	•			Closing windows
•	CAN		*•	Engine pre-heaters

## Arming mode

The arming mode monitors guarded zones and provides engine blocking. If one of the guarded zones is triggered, the system will record this event in its non-volatile memory, activate the alarm or warning mode and inform an owner with an indication of the zone. If the system is armed, the engine is running, and one of the guarded zones is triggered, the system will stop the engine.

Arming/disarming, alarm mode and warnings are accompanied by sound and light signals. The system confirms arming with 1 sound signal and 1 flash of the turn indicators. The system confirms disarming with 2 short sound signals and 2 flashes of the turn indicators. If one of the guarded zones is opened, the system will produce 4 warning sounds and 4 flashes of the turn indicators at the moment of arming. The system will also produce 4 warning sounds and 4 flashes of the turn indicators at the moment of disarming if there were alarm events during the armed period. The system activates light and sound signals for 30 seconds in the alarm mode. The alarm signals can be canceled by an arming or disarming command. If a warning zone is triggered, the system will produce 1 sound signal and 1 flash of the turn indicators.

If one of the guarded zones fails, the system will forcibly turn off this zone. If a switch triggers more than 9 times in a row, it will be disabled until the next arming. The shock/tilt/motion sensor is temporarily deactivated (15 sec.) if it has been triggered more than 3 times in a row.

## Multi-button code immobilizer

Multi-button code immobilizer (pin-to-drive) is a function that allows disarming, disabling blocking and controlling service mode and time channels using original vehicle controls (button, lever or pedal) and a pre-programmed PIN-code (the "Immobilizer PIN-code"). The function works using special analog inputs or digital buses of a car.

An example of using the function:

- Turn on the ignition to disable engine blocking or service mode, turning on the ignition is not required if you want to disarm the system or control time channels.
- Enter the "Immobilizer PIN-code". Press a programmed button/lever/pedal the number of times equals to the first digit. Pauses between presses should not exceed 1 second. More than 1 second pause will be interpreted as the start of the next digit input. The immobilizer code can consist max of 4 digits from 1 to 9.
- The system will confirm the correct input by a sound signal of the beeper and a programmed function will be performed.

---

NOTE! IT IS REQUIRED TO MAKE ADDITIONAL CONNECTIONS AND SETTINGS TO USE THIS FUNCTION.

---

### Immobilizer mode

When switching on the ignition, a base unit of the security system performs a search for immobilizer tags in radio zone. If no radio tags are detected at the time of switching on the ignition, the system will block the engine. Engine blocking will occur immediately or at the time a motion sensor detects movement, it depends on the system settings.

---

**WARNING! IF THE SYSTEM DOES NOT RECOGNIZE A RADIO TAG, THE BEEPER WILL EMIT 5 SOUND SIGNALS WHEN THE IGNITION IS TURNED ON, THIS WILL REPEAT 5 TIMES. CHECK A RADIO TAG BATTERY, MOVE A TAG (IT GOES TO THE SLEEP MODE WHEN IT REMAINS MOTIONLESS AND THE IGNITION IS OFF. A BUILT-IN ACCELEROMETER HAVE TO RECOGNIZE MOVEMENT TO ACTIVATE A TAG).**

---

NOTE! THIS MODE IS ENABLED BY DEFAULT. USE THE PANDORA BT OR PANDORA ALARM STUDIO TO ENABLE/DISABLE THIS MODE.

---

### Anti-Hi-Jack mode

The Anti-Hi-Jack mode helps to prevent aggressive seizure of a car using delayed engine blocking on door opening. Every time on opening/closing a door when the ignition is on, the system requests a response from a radio tag using a unique algorithm. After a door was opened while the ignition is on, if the system cannot detect a radio tag, the engine will be stopped after 1 minute (general safety requirement). The siren will play the 'ENGINE BLOCKING WARNING' ringtone before blocking. The engine will be blocked immediately or at the time the car starts moving, it depends on system settings. Blocking will be disabled if the system detects a radio tag.

---

NOTE! THIS MODE IS DISABLED BY DEFAULT. USE THE PANDORA BT OR PANDORA ALARM STUDIO TO ENABLE/DISABLE THIS MODE.

---

### Anti-Hi-Jack 2 mode

The Anti-Hi-Jack-2 mode helps to prevent aggressive seizure of a car using delayed engine blocking on radio tag disappearance. The system constantly requests a response from a tag using a unique algorithm when the ignition is on. If the system cannot detect a radio tag, the engine will be stopped after 1 minute (general safety requirement for car movement). The siren will play the 'ENGINE BLOCKING WARNING' ringtone before blocking. When warning signals end, the system will block the engine. Engine blocking will occur immediately or at the time the car starts moving, it depends on block implementation and system settings.

---

NOTE! THIS MODE IS DISABLED BY DEFAULT. USE THE PANDORA BT OR PANDORA ALARM STUDIO TO ENABLE/DISABLE THIS MODE.

---

### IMMOBILIZER RADIO TAG

A radio tag is control device of security and anti-theft functions of the system used for concealed carrying. The tag is used to authorize a user in the radio coverage zone of the base unit for such modes as "Immobilizer", "HandsFree", "Slave".

The tag has a control button for arming/disarming and switching on and off the service mode. A built-in motion sensor allows the tag to go into energy saving mode when there is no movement. The tag also has a LED indicator "SEND".

• Control button
• Built-in LED indicator "SEND"
• Built-in accelerometer
• Battery CR 2032 (not included in the set)
• 2.4 GHz radio frequency (dialog encryption AES-128)
• Bluetooth-протокол 



**Light indication of the SEND indicator of the radio tag when there is a short press of the button:**

- No flashes – the battery is discharged.
- 1 flash – the radio tag operation is correct.

**Light indication of the SEND indicator of the radio tag when installing a battery:**

- No flashes – the battery is discharged.
- 1 flash – low battery level.
- 3 flashes – high battery level.

---

**WARNING! AVOID MOISTURE ON THE RADIO TAG. DO NOT PLACE THE RADIO TAG NEAR MAGNETS OR PRODUCTS WITH SELF-MAGNETIC FIELDS.**

---

### Replacing an immobilizer tag battery

Carefully open the cover of the tag battery compartment. Remove a discharged battery and insert a new one keeping in mind the correct polarity.

Replacing a battery will not cause a loss of tag code information, as authorization data is stored in the non-volatile memory of the MCU. Carefully close the cover of the tag battery compartment. All elements of construction should be rigidly locked in places. If it is so, the tag can be operated as usually.



## MOBILE APPLICATIONS

The mobile applications Pandora Online (for Android) and Pandora Pro (for iOS) are additional tools to control the system state. The connection is established only with one phone that was previously paired with the system via a special Bluetooth Low Energy protocol

---

**WARNING! MINIMUM REQUIREMENTS FOR MOBILE DEVICES: PANDORA ONLINE - ANDROID v4.4, BLUETOOTH 4.0 LOW ENERGY; PANDORA PRO - iOS v10.**

---

### Installing the applications

Download the mobile apps from your device's app store (Google Play – Pandora Online, App Store – Pandora Pro). Enter the system programming mode and pair your phone with the system after the installation.

Replacing a battery will not cause a loss of tag code information, as authorization data is stored in the non-volatile memory of the MCU. Carefully close the cover of the tag battery compartment. All elements of construction should be rigidly locked in places. If it is so, the tag can be operated as usually.

### Pairing and unpairing a mobile device

To pair (unpair) a mobile device, enter the programming mode and go to the programming level №18 "Pairing and unpairing a mobile device".

#### Entering the programming mode:

To enter the programming mode, enter the "Service PIN-code" using the VALET button (factory pre-set is "1-1-1-1"). Entering the «Service PIN-code» is similar to entering the «Secret PIN-code» (see the "Control over the system in case of emergency" section).

To proceed to the programming level №18, press the VALET button 18 times after entering the programming mode.

#### Pairing a mobile device:

The LED indicator will light green after entering the level. Open the 'Pandora Online' or Pandora Pro mobile application.

Pandora Online – press the "Bluetooth" icon, press the menu icon in the top right corner and use "Add Bluetooth device" function. The application will search for the system via a Bluetooth connection. Select the found system, the system and the mobile device will be automatically paired.

Pandora Pro – press the “Bluetooth devices” button in the top right corner and press the “+” icon. The application will search for the system via a Bluetooth connection. Select the found system, the system and the mobile device will be automatically paired.

THE SYSTEM WILL CONFIRM THE PAIRING WITH A SOUND SIGNAL OF A SIREN AND RED LIGHT OF THE LED INDICATOR.

NOTE! If there is no automatic pairing, enable the “PIN request for phone pairing” item in the “Radio tag and mobile device functions” settings and make the pairing procedure again. A mobile device will request a PIN-code (Factory pre-set is 0-0-1-1-1-1 where 4 last digits are the “Service PIN-code”

#### Unpairing a mobile device:

The LED indicator will light red after entering the level. Press the VALET button and hold it for more than 4 seconds, release the button. The system will confirm deleting with the series of sound signals of a siren and the system will return to the mobile device registration mode (the LED indicator will light green).

#### Saving changes:

To finish pairing (unpairing) a mobile device, the VALET button should be pressed once, the series of red and green flashes of the status LED indicator will confirm the saving, switch on the ignition to automatically save the settings and exit the programming mode.

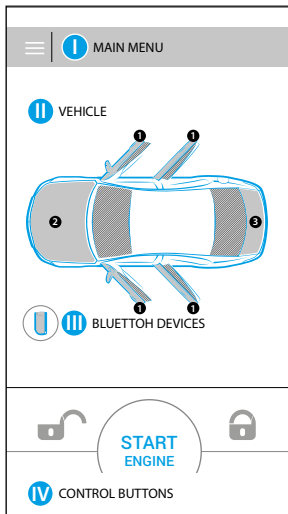

## CONTROL OVER THE SYSTEM

### Arming

To arm the system when the ignition is off, use one of the methods described below. The system will confirm the command receiving with 1 short sound signal and 1 flash of turn indicators.

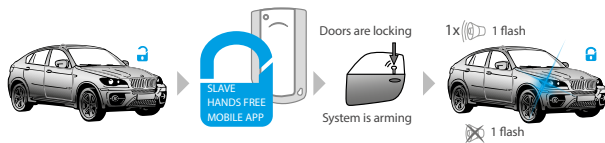

### SLAVE mode

This mode allows arming using special analog inputs or digital connections to a car. To arm the system, shortly press the “Lock” button on an original remote control or use a sensor/button on a door handle (for cars with an intelligent access system).

NOTE! ADDITIONAL SETTINGS OR CONNECTIONS ARE REQUIRED FOR THIS MODE.

### Mobile application

Open the mobile application. When the system is active, press and hold the button  on the control panel until the scale is fully loaded

### Radio tag

A radio tag must be in the Bluetooth coverage area. Shortly press the control button on the tag.

### HandsFree mode

Move with a remote tag (or a paired mobile phone) away from your vehicle 

NOTE! ADDITIONAL SETTINGS ARE REQUIRED FOR USING THE HANDSFREE MODE WITH A MOBILE PHONE.

### VALET button

Press and hold the VALET button for 3 seconds. The system will be armed in 30 seconds. The LED

indicator is lighting red during the countdown.

There is an option in the system settings that allows to arm the system with disabled sensors (shock/tilt/motion and additional sensors). The setting "Switch off sensors when arming using VALET button" is available in the Alarm Studio ("Main settings" – "Sensors settings")

### Disarming

To disarm the system, use one of the methods described below. The system will confirm the command receiving with 2 short sound signal and 2 flash of turn indicators.

If there were alarm events during the arming period, siren will sound 4 times and turn signals will flash 4 times.

---

**WARNING! It is recommended to use the "IMMOBILIZER MODE" AND "PROHIBIT DISARMING WHEN THE TAG IS ABSENT" FUNCTION TO INCREASE ANTI-THEFT PROTECTION.**

---

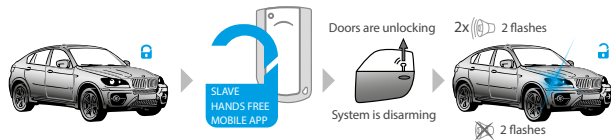

### SLAVE mode

This mode allows disarming using special analog inputs or digital connections to a car.

To disarm the system, shortly press the "Unlock" button on an original remote control or use a sensor/button on a door handle (for cars with an intelligent access system).

---

NOTE! ADDITIONAL SETTINGS OR CONNECTIONS ARE REQUIRED FOR THIS MODE..

---

### Mobile application

Open the mobile application. When the system is active, press and hold the button  on the control panel until the scale is fully loaded.

### Radio tag

A radio tag must be in the Bluetooth coverage area. Shortly press the control button on the tag.

### HandsFree mode

Move toward the vehicle with a remote tag (or a paired mobile phone) .

---

NOTE! ADDITIONAL SETTINGS ARE REQUIRED FOR USING THE HANDSFREE MODE WITH A MOBILE PHONE.

---

### VALET button



Enter the "Secret PIN-code" (see the "Emergency disarming using the VALET button" section).



## SERVICE (VALET) MODE

It is recommended to put the system into the service mode before handing it to a car service or valet parking. When this mode is switched on, security system stops interfering with built-in electronics and disables all functions to ease maintenance or parking.

**To enable this mode, switch on the ignition, a radio tag must be in the coverage zone, enter the "Immobilizer PIN-code" (if the "Code immobilizer" function is implemented) and use one of the methods described below: Switch on/off the service mode using a phone and the Pandora BT application**

- To switch on the service mode, open the mobile application. When the system is active, press and hold the button  on the control panel until the scale is fully loaded.
- To switch off the service mode, open the mobile application. When the system is active, press and hold the button  on the control panel until the scale is fully loaded.

NOTE! IN ORDER TO CHANGE BUTTONS LOCATION OR TO ADD A NEW BUTTON ON THE CONTROL PANEL, PROCEED TO THE "SETTINGS" -> "ACTION BUTTONS".

### Switch on/off the service mode using a radio tag

- To switch on the service mode, press and hold the button on a radio tag for 3 seconds. Release the button after 3 flashes of the LED of the radio.
- To switch off the service mode, press and hold the button on a radio tag for 3 seconds. Release the button after 3 flashes of the LED of the radio tag.
- Switch on/off the service mode using an immobilizer button
- To switch on the service mode, enter the "Immobilizer PIN-code" and press the immobilizer button 10 times within 20 seconds.
- To switch off the service mode, turn on the ignition and enter the "Immobilizer PIN-code".

### Service mode indication

The system will confirm switching on the service mode with:  icon in the mobile application, with a long sound signal of a Beeper and the green LED indicator when the ignition is turned on.

The system will confirm switching off the service mode with: disappearing the  icon in the mobile application, two long sound signals of a Beeper and fading the green LED indicator when the ignition is turned on.

## CONTROL OVER THE SYSTEM IN CASE OF EMERGENCY

### Emergency disarming using the VALET button

In case you cannot disarm the system using a phone or immobilizer tag, the 'Secret PIN-code' can be used. The 'Secret PIN-code' is written on the owner's plastic card under the protective layer. The code must be entered only when the base unit is powered and the ignition is off. The PIN-code can be entered using an external or located on the base unit VALET button. The digits input is indicated by an external or located on the base unit LED indicator.

**WARNING! MAKE SURE THAT THE PROTECTIVE LAYER ON THE OWNER'S PLASTIC CARD IS INTACT AFTER AN INSTALLATION OF THE SYSTEM. THE PLASTIC CARD HOLDS THE "SECRET PIN-CODE"**

**WARNING! CAREFULLY REMOVE THE PROTECTIVE LAYER, DO NOT USE SHARP OBJECTS TO AVOID DAMAGING OF HIDDEN INFORMATION UNDER THE PROTECTIVE LAYER.**

### Entering the PIN-code:

• **ENTER THE FIRST DIGIT** • Press the VALET button the number of times, equals to the first digit. Pauses between presses should not exceed 1 second. Each pressing will be confirmed with an orange LED indicator flash. A pause for more than 1 second and, red LED indicator flash and a short sound signal of the beeper confirms the input of the first digit. Then you can enter the next digit.

• **ENTER THE SECOND DIGIT** • Press the VALET button the number of times, equals to the second digit. Pauses between presses should not exceed 1 second. Each pressing will be confirmed with an orange LED indicator flash. A pause for more than 1 second and, red LED indicator flash and a short sound signal of the beeper confirms the input of the second digit. Then you can enter the next digit.

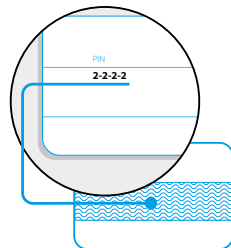

• **ENTER THE THIRD DIGIT** • Press the VALET button the number of times, equals to the first digit. Pauses between presses should not exceed 1 second. Each pressing will be confirmed with an orange LED indicator flash. A pause for more than 1 second and, red LED indicator flash and a short sound signal of the beeper confirms the input of the first digit. Then you can enter the next digit.

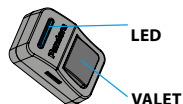

• **ENTER THE FOURTH DIGIT** • Enter the fourth digit of the code using VALET button. Press the button the number of times, equals to the fourth digit. Pauses between presses should not exceed 1 second. Each pressing will be confirmed with an orange LED indicator flash. After entering the fourth digit:

- If the PIN-code is correct, the system will be disarmed. It will be confirmed with the series of red and green flashes of the LED sound signals of the Beeper, two signals of the siren and two flashes of the light signalization
- If the PIN-code is incorrect the system will stay in the previous state. New input can be attempted after 5 seconds. Incorrect PIN-code is indicated with a long red flash of the LED.
- If the system was disarmed and the ignition was off, it will enter the programming mode after correct entering the "Secret PIN-code". Turn on the ignition to exit the programming mode.

## Emergency disabling immobilizer radio tags

**WARNING!** IT IS HIGHLY RECOMMENDED TO CHANGE THE FACTORY PRESET OF THE "SERVICE PIN-CODE" FOR IMPROVING SECURITY OF THE SYSTEM



Write down or remember the "Service PIN-code"

To disable radio tags, enter the programming mode and then enter the level №15 "Disabling/Enabling immobilizer radio tags". Enter the 'Secret PIN-code' to disable the radio tags or press the VALET button once to enable the radio tags

## Entering the programming menu:

Enter the "Service PIN-code" to enter the programming mode (factory preset of the service PIN-code is '1-1-1-1'). Entering the "Service PIN-code" is similar to entering the "Secret PIN-code" (see the "Entering the PIN-code" section above). You can enter the code only if the base unit is powered, the ignition is off, the system is disarmed and the service mode is switched off.

NOTE! IF THERE IS NO 'SERVICE PIN-CODE', YOU CAN ENTER THE PROGRAMMING MODE USING THE 'SECRET PIN-CODE' WRITTEN ON THE OWNER'S CARD.

## Entering the level №15 "Disabling/Enabling immobilizer radio tags":

After entering the programming mode, press the VALET button 15 times, pauses between presses should not exceed 1 second. Each pressing will be confirmed with an orange LED indicator flash. The system will confirm entering the level by 15 red flashes of the LED and short sound signals of the beeper and siren.

## Disabling radio tags:

The LED indicator will light green after entering the programming level. The system will wait for entering the 'Secret PIN-code'. If the PIN-code is not entered within 10 seconds or the input is incorrect, the siren will sound one signal, the LED will produce the series of red and green flashes and the system will return to the programming menu. Enter the 'Secret PIN-code' that is written on the owner's plastic card. The system will confirm disabling immobilizer radio tags with a long red LED flash, two sound signals of the siren and sound signals of the beeper. Turn on the ignition to exit the programming mode.

## Enabling radio tags:

The LED indicator will light red and the beeper will emit a long sound signal after entering the programming level. The system will wait for an action. Press the VALET button once to enable the radio tags. The system will confirm enabling with a green LED light and one short sound signal of the siren and beeper. Turn on the ignition to exit the programming mode.

## SYSTEM INSTALLATION

### General installation requirements

- Install the base unit only inside car interior.
- Install securely each system's component, as conditions of the car standard operation can harm functionality of the alarm system and cause damage to the car original systems, including the elements of safety in motion.
- The system installation should be performed when the system sockets and the negative battery terminal are disconnected.
- The base unit power supply should be switched off when connecting to CAN-bus.
- The system installation can be performed via twisting together or via lead-tin soldering followed by isolation of a switching place.
- When wiring, pay attention to sections and materials of switched conductors, if they are different, bring electrochemical potentials to the minimal difference. The isolation should not allow for moisture to reach wiring, as the presence of moisture will increase electrochemical destruction of wires (this is especially important for the large current circuits).
- Switched connections should be placed as high as it is possible in the cavities so water condensate will not form drops on the switching location.
- To avoid the destruction of compounds by car vibration, ensure that there is a bit of free length to the wiring, providing enough sagging.
- Do not allow wiring in places where the wires isolation can be destroyed by abrasion.
- Electronic system units should be placed sockets down and as high as possible to avoid condensate reaching electronic components through the socket.
- When installing base unit, secure it to the car body for correct operation of in-built shock sensor.
- All unused system wires during the installation must be insulated and secured to prevent accidental touching of a car body or other wires.

### Wiring description

**Wire №1 (White)** — "LED/VALET". This wire connects to the red wire of the external VALET button.

**Wire №2 (Red-black) 200mA (-) INP6/CH6** — Factory setting is Beeper. This wire connects to the black wire (-) of the sound emitter Beeper. The red wire of the beeper connects to a reliable conductor with constant voltage of +12V.

**Wire №3 (Orange-white) CAN1-H** — wire of digital bus CAN1-High. It connects to an appropriate CAN-High wire of a car.

**Wire №4 (Yellow-white) 200mA (-) CH2/CAN2-H** — wire of digital bus CAN2-High. It connects to an appropriate CAN2-High wire of a car. This channel can be assigned as an output, it will not work as a digital bus in this case.

**Wire №5 (Gray) 200mA (-) CH1/ INP1** — Factory setting is "Code immobilizer", see description in the "Programming the immobilizer PIN-code" section.

**Wire №6 (Green) 200mA (-) CH4/ INP4** — Factory setting is "N.O. blockage". This wire is used to control a blocking relay with a normally open logic. This channel is activated (a relay is closed – blockage is not active) when the system is disarmed, ignition is switched on and a radio tag is in the coverage zone (immobilizer mode).

**Wire №7 (White-blue) (+) INP5** — Factory setting is "Brake pedal", it is a guarded and controlled zone. This wire connects to a brake pedal switch where +12V voltage appears when the pedal is pressed (stop lights wire).

**Wire №8 (Black) (-) — Ground.** This wire must be connected to the ground of a car. This wire must be connected first during installation.

**Wire №9 (Blue) CH3** — «"LED/VALET"». This wire connects to the black wire of the external VALET button.

**Wire №10 (Brown-white) 200mA (-) CH3/INP3** — Factory setting is "Front hood", it is a guarded and controlled zone. This wire connects to appropriate wire that becomes grounded when the front hood opens.

# Pandora Mini v2 WIRING DIAGRAM

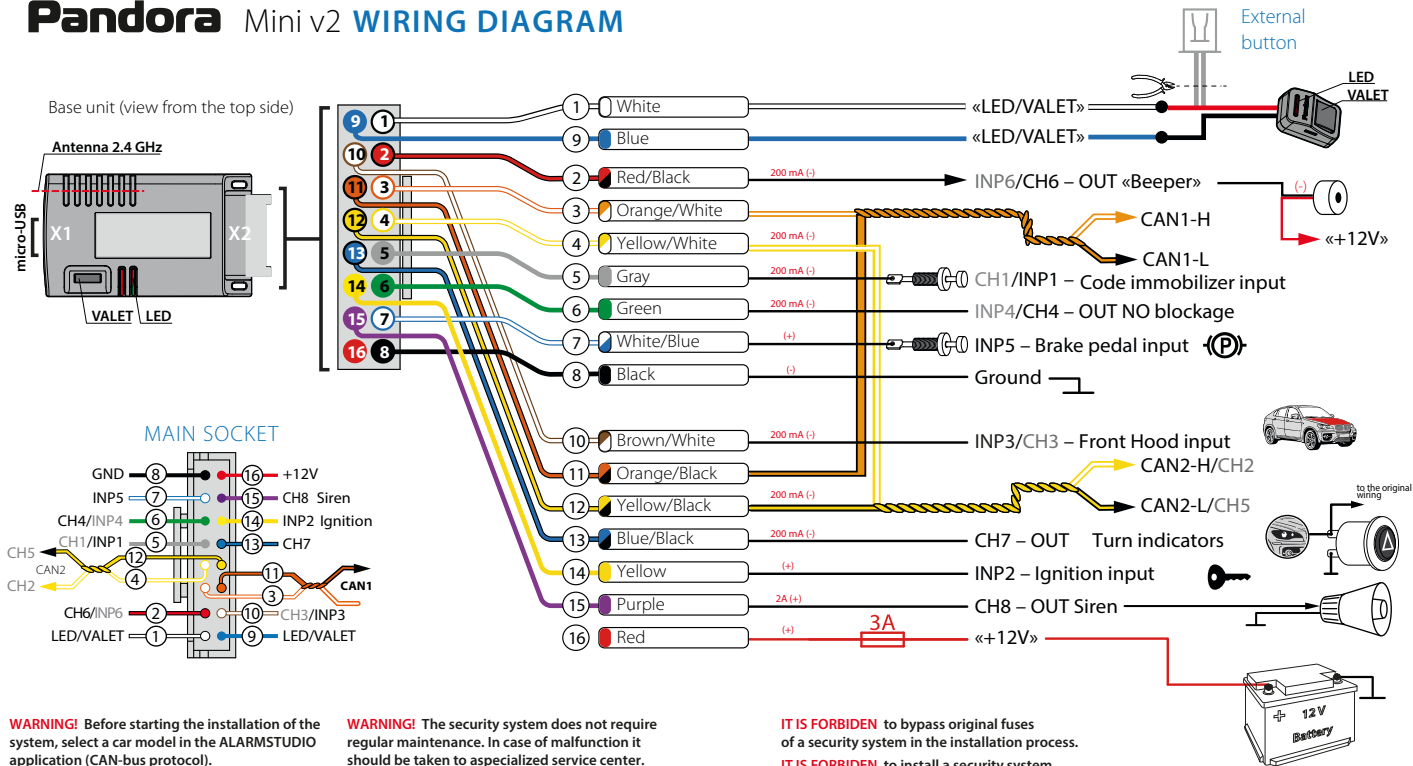

**WARNING!** Before starting the installation of the system, select a car model in the ALARMSTUDIO application (CAN-bus protocol).

**WARNING!** All power circuits of additional devices that are not powered through base unit of the system should have their own fuses.

**WARNING!** The security system does not require regular maintenance. In case of malfunction it should be taken to a specialized service center.

**WARNING!** Do not shield the built-in antennas.

**IT IS FORBIDDEN** to bypass original fuses of a security system in the installation process.

**IT IS FORBIDDEN** to install a security system with damaged output cables.

**IT IS FORBIDDEN** to install the system on a car with normal voltage other than 12V.

**Wire №11 (Orange-black) CAN1-L** — wire of digital bus CAN1-Low. It connects to an appropriate CAN-High wire of a car..

**Wire №12 (Yellow-black) 200mA (-) CH5/CAN2-L** — wire of digital bus CAN2-Low. It connects to an appropriate CAN2-High wire of a car. This channel can be assigned as an output, it will not work as a digital bus in this case.

**Wire №13 (Blue-black) 200mA (-) CH7** — Factory setting is "Turn lights". This wire connects to a hazard flashers button of a car.

**Wire №14 (Yellow) (+) INP2** — Factory setting is "Ignition" input, it is a guarded and controlled zone. This wire connects to an appropriate wire where 12V voltage appears when ignition is switched on. If there is no ignition status in a CAN-bus, this input must be connected.

**Wire №15 (Purple) 2A (+) CH8** — Factory setting is "Siren". It connects to a siren control wire (+).

**Wire №16 (Red) (+)** — power supply of the system "+12V". It must be connected to a reliable conductor with constant voltage of 12V.

## SYSTEM CONFIGURATION AND PROGRAMMING

The Pandora Alarm Studio application is used for system configuration. Some functions can be configured only using the VALET button and programming menu of the system.

To change the system settings and program the system using a computer or the VALET button, the system must be in the programming mode.

### Entering the programming mode

You can enter the programming mode only if the base unit is powered from USB socket or from an external power supply, the ignition is off, the system is disarmed and the service mode is switched off.

Enter the programming mode by entering the 'Service PIN-code' (factory preset is 1-1-1-1). The PIN-code should be entered using an external or located on the base unit VALET button. The input is indicated by flashes of an external or located on the base unit LED indicator.

The system stops to perform control commands while it is in the programming mode.

---

NOTE! SEE THE "CONTROL OVER THE SYSTEM IN CASE OF EMERGENCY" SECTION FOR DESCRIPTION OF THE PIN-CODE ENTERING PROCEDURE.

NOTE! IF THERE IS NO 'SERVICE PIN-CODE', YOU CAN ENTER THE PROGRAMMING MODE USING THE 'SECRET PIN-CODE' WRITTEN ON THE OWNER'S CARD

---

**WARNING! IT IS PROHIBITED TO ERASE THE PROTECTIVE LAYER ON THE OWNER'S CARD. THE INFORMATION ON THE CARD IS INTENDED ONLY FOR THE OWNER OF THE SYSTEM.**

---

### Exiting the programming mode

There are several ways to exit the programming mode:

Switch on the ignition

Press and hold the VALET button more than 10 seconds (until a siren sound)  
Disconnect power of the base unit (disconnect the main power supply and USB)

The system will reboot programmatically (all changes will be saved) after exiting programming mode. All ways to exit the programming menu are accompanied by sound signals of the siren and light signals of the LED indicator.

The signals indicate the number of recorded control devices

---

NOTE! SEE THE "INFORMATION" SECTION FOR DESCRIPTION OF SIGNALS INDICATING THE NUMBER OF RECORDED CONTROL DEVICES

---

## Pandora Alarm Studio

The Pandora Alarm Studio allows configuring the main parameters of the system, uploading firmware updates, downloading installation guides, making the "Pandora CLONE" procedure.

### In preparation to programming, these stages should be followed:

- Install the Pandora Alarm Studio to a PC with Windows XP/Vista/7/8/10;
- Start the Pandora Alarm Studio;
- Connect the system and PC via a USB cable;
- Enter the programming mode by entering the service PIN-code;
- The application will automatically open the settings window.

It is recommended to update firmware of the base unit before installing and programming the system (actual version of the firmware you can download from pandorainfo.com or from the Alarm Studio). You can update firmware using the Alarm Studio application after entering the programming mode:

- Press the "Update software" button and select a type of updating;
- "Load from file" – select previously downloaded firmware on your PC, "Firmware archive" - firmware will be downloaded from a server to the "firmwares" folder.
- Select a firmware file and press the "Update" button;

Exit the programming mode after changing the settings or updating firmware.

---

NOTE! IF AN UPDATING PROCESS HAS BEEN INTERRUPTED FOR SOME REASON AND THE STATUS INDICATOR LIGHTS RED, YOU NEED TO USE THE "QUICK BOOT MODE" TO UPLOAD FIRMWARE. OPEN THE ALARM STUDIO; DE-ENERGIZE AND DISCONNECT THE SYSTEM; PRESS AND HOLD THE VALET BUTTON LOCATED ON THE BASE UNIT; RELEASE THE BUTTON IMMEDIATELY AFTER CONNECTING THE SYSTEM AND A COMPUTER VIA USB CABLE; THE SYSTEM WILL ENTER THE BOOT MODE.

---

## Programming menu

Use the VALET button to enter the desired level number after entering the programming menu:

- Press the button the number of times, equals to the level number, pauses between presses should not exceed 1 second;
- The system will confirm correct input with red LED flashes and short sound signals of a siren and proceed to the desired level.
- If the input was incorrect, the system will not confirm input and will await a new level input after a series of green and red flashes.

### Programming levels table

Level number	Function
Level №1	Recording a remote control/radio tags
Level №2	Changing the factory preset of the service PIN-code
Level №3	Recording the idle speed (rpm) to the system memory
Level №4	Resetting to the factory settings
Level №5	Recording a Bluetooth engine compartment module
Levels №6, №7	Recording Bluetooth radio relays
Level №8	Recording a Bluetooth GPS/GLONASS receiver
Level №11	Programming the "Immobilizer PIN-code"
Level №15	Emergency disabling immobilizer radio tags
Level №16	Updating firmware of the built-in Bluetooth modem
Level №18	Pairing and unpairing a mobile device

Levels №19, №20	Updating firmware of radio relays №1, №2
Level №21	Updating firmware of an engine compartment module
Level №22	Updating firmware of a GPS/GLONASS receiver
Levels №23, №24	Recording door sensors №1, №2
Levels №25, №26	Updating firmware of door sensors №1, №2
Level №27	Recording an additional module
Level №28	Updating firmware of additional modules

### Compatibility table

Level	Number and name of additional devices	
№1	3 - BT760	1 - D030
№5	1 - RHM-03 BT	
№6/№7	2 - BTR-101	
№8	1 - NAV-035 BT	
№18	1 – Mobile device	
№23/№24	2 - DMS-100 BT	
№27	1 - DI-04 or BT-01	

NOTE! THE ADDITIONAL DEVICES THAT ARE INCLUDED IN THE SYSTEM SET HAVE BEEN ALREADY RECORDED IN THE SYSTEM MEMORY (SEE THE "SYSTEM SET" SECTION OF THE USER MANUAL).

### Level №1 – Recording a remote control/radio tags

Prepare to record all devices – insert batteries, switch on all devices in accordance with the manuals. All previously recorded devices will be removed from a memory cell when you overwrite new device or overwrite old device. All other memory cells will be not overwritten (see the compatibility table). The LED indicator will light green after entering the level and the system will enter the remote controls and tags recording mode. Devices are recorded one by one in any order and without time limit. To finish the recording of radio tags into the system, VALET button should be pressed once, the series of red and green flashes of status LED indicator will confirm saving.

#### Recording a radio tag:

- Press the control button on a tag and hold it for 6 seconds (6 flashes of the tag status indicator), release the button after the sixth flash. If the recording was successful, a siren will emit 1 beep, after this you can move to recording the next tag.

#### Recording a remote control:

- Press and hold three buttons of a remote control (arm/disarm/F) simultaneously for 1 second (until a short beep, then release the buttons).
- If recording was successful, the siren will emit 1 sound signal. After this, you can move to recording the next device.

### Level №2 – Changing the factory preset of the service PIN-code

Prepare a new value of the 'Service PIN-code', it should consist of 4 digits (from 1 to 9). Write down or remember the new PIN-code.

The system will enter 'Changing the Service PIN-code' mode and the status LED indicator will turn off after entering the level.

#### Changing the 'Service PIN-code':

- Enter the first digit of the code using the VALET button. Press the button a number of times, equals to the first digit. Pauses between presses should not exceed 1 second, every pressing will confirm with an orange LED indicator flash. A pause for more than 1 second and red LED indicator confirms the input of the first digit. Then you can enter the next digit;
- Enter the other numbers in the same manner. The input of the fourth number will be confirmed by the series of red and green LED indicator flashes. The system will wait for PIN-code re-entering;
- Enter all four digits again;

- If you were able to correctly enter the 'Service PIN-code' twice, the indicator will produce the series of red and green flashes, the new PIN-code will be recorded, the system will return to programming mode.
- In case of the incorrect code input the indicator will be lit red, the system will return to the programming mode.

### Level №3 – Recording the idle speed (rpm) to the system memory

To timely turn off the starter during automatic or remote engine start via digital or analog tachometer input and the correct operation of the 'Smart Turbo Timer', it is necessary to record the engine idle speed.

Switch on the ignition and start the engine after entering this level of programming (the engine should be warmed-up; idle speed should match the stable idle speed of the warmed-up engine). The system will confirm the presence of the idle speed status with green flashes of the LED indicator. Wait until the stable idle speed will be reached and save the changes by pressing the VALET button. Successful recording of the idle speed will be confirmed with the series of red and green flashes of LED indicator and a siren signal. The series of siren signals will indicate incorrect recording. The system will exit the programming menu and reboot after saving the idle speed.

### Level №4 – Resetting to the factory settings

The procedure recovers the factory settings of the system without deleting previously registered devices (remote controls, tags, mobile device, relays, etc.) that is stored in the non-volatile memory.

Press and hold the VALET button for more than 4 seconds until a siren signal, then release the button. The system will confirm resetting to the factory settings with a long red flash of the LED indicator. After that the system will return to the programming mode.

### Level №5 – Recording a Bluetooth engine compartment module

The LED indicator will light green and the system will enter the recording of an engine compartment module mode.

#### Recording a Bluetooth engine compartment module (RHM-03 BT):

- Enter the programming level №5;
- Connect the wire 4 ("LIN output/Programming") and wire 5 ("Ground"). Connect them to a grounded spot of a car;
- Apply +12V to the wire 7 (" +12V Power supply of the module");

- The system will confirm recording of the module to the system memory with 1 beep of the siren;
- Disconnect the wire 4 ("LIN output/Programming") from the wire 5 and insulate it.
- Press the VALET button to finish recording. The series of red and green flashes of the status LED will confirm saving.

### Levels №6/№7 – Recording Bluetooth radio relays №1, №2

Radio relays recording is performed one by one starting from the 6th level: a radio relay №1 is recorded on the 6th level; a radio relay №2 is recorded on the 7th level. The radio relay can be overwritten only on the level of its initial registration.

The LED indicator will light green and the system will enter the recording of a radio relay mode.

#### Recording a radio relay (BTR-101):

- Enter the programming level №6 or №7;
- Connect the wire 1 ("Ground") to a grounded spot of a car;
- Connect the wire 3 ("Programming") and wire 4 (" +12V Power supply of the radio relay"). Connect them to +12V;
- The system will confirm recording of the radio relay to the system memory with 1 beep of the siren;
- Disconnect the wire 3 ("LIN output/Programming") from the wire 4 and insulate it;
- Press the VALET button to finish recording. The series of red and green flashes of the status LED will confirm saving.

### Level №8 – Recording a Bluetooth GPS/GLONASS receiver

The LED indicator will light green and the system will enter the recording of a GPS/GLONASS receiver mode.

#### Recording a Bluetooth GPS/GLONASS receiver (NAV-035 BT):

- Enter the programming level №8;
- Connect the wire 2 ("Ground") to a grounded spot of a car;
- Apply +12V to the wire 1 (" +12V Power supply of the receiver");
- The system will confirm recording of the receiver to the system memory with 1 beep of the siren.
- Press the VALET button to finish recording. The series of red and green flashes of the status LED will confirm saving.



## Level №11 – Programming the “Immobilizer PIN-code”

The level is divided into 3 sublevels (Sublevel 11.1 – Selecting buttons; sublevel 11.2 entering the PIN-code; sublevel 11.3 – confirmation of the PIN-code input).

The system will automatically enter the sublevel 11.1 (Selecting buttons) after entering the level 11. The VALET button is used to proceed to the next sublevels and to save the “Immobilizer PIN-code”

### • №11.1 - Selecting buttons

The system will wait for pressing buttons after entering this sublevel. Each pressing of an active button will be indicated by an orange flash of the LED. You can turn on the ignition on this sublevel, the system will not exit the programming mode (some buttons are active only when ignition is on). The system can determine active buttons via a digital bus of a car or via a ‘Code Immobilizer’ analog input.

### • №11.2 - Entering the PIN-code

This sublevel is used to program the immobilizer deactivation PIN-code using the selected buttons. The code can consist of one or more memory cells, each memory cell can store a sequence of pressing each of the five selected immobilizer buttons.

The code is entered by pressing the selected buttons for at least 1 second. Each pressing is confirmed with an orange flash of the LED. A pause for more than 1 second and the red LED confirms the input for the current memory cell, you can start entering the next memory cell.

### • №11.3 - Confirmation of the PIN-code input

Confirm the entered PIN-code on this level. Repeat the procedure described above. The system will compare two inputs after that.

- The system will confirm the correct PIN-code with red and green flashes of the LED indicator and will memorize the PIN-code, and then the system will proceed to the programming mode awaiting level input.

- Incorrect confirmation is indicated with a long red flash of the LED indicator, the system will cancel the input and return to the programming mode.

## Level №15 – Emergency disabling immobilizer radio tags

---

NOTE! DETAILED INSTRUCTION IS IN THE “CONTROL OVER THE SYSTEM IN CASE OF EMERGENCY” SECTION

---

## Level №18 – Pairing and unpairing a mobile device

The system supports only one mobile device. Pairing a new mobile device (if the system has previously paired device) is not allowed without unpairing procedure. When you overwrite the same device in the system memory, you should delete the Bluetooth connection on your mobile device, delete the mobile device from the system memory and then record the mobile device in the system memory.

The LED indicator will light green (a green light indicates the system is ready to pair a mobile device) and the system will enter the mobile device pairing mode. A red light of the LED indicates the system has already had paired mobile device, overwriting of the mobile device can be done only after unpairing procedure.

---

NOTE! DETAILED INSTRUCTION IS IN THE “MOBILE APPLICATIONS” SECTION

---

**WARNING! IF THERE IS NO AUTOMATIC PAIRING, ENABLE THE “PIN REQUEST FOR PHONE PAIRING” ITEM IN THE “RADIO TAG AND MOBILE DEVICE FUNCTIONS” SETTINGS AND MAKE THE PAIRING PROCEDURE AGAIN. A MOBILE DEVICE WILL REQUEST A PIN-CODE (FACTORY PRE-SET IS 0-0-1-1-1-1 WHERE 4 LAST DIGITS ARE THE “SERVICE PIN-CODE**

---

## Levels №23/№24 – Recording door sensors №1, №2

Door sensors recording is performed one by one starting from the 23rd level: A door sensor №1 is recorded on the 23rd level; a door sensor №2 is recorded on the 24th level.

The LED indicator will light green and the system will enter the recording a door sensor mode.

### **Recording a door sensor (DMS-100BT):**

- Enter the programming level №23 or №24;
- Insert a battery in the sensor;
- The system will confirm recording of the sensor to the system memory with 1 beep of the siren;
- Press the VALET button to finish recording. The series of red and green flashes of the status LED will confirm saving

### Level №27 – Recording an additional module

The system supports only one device DI-04 or BT-01.

The LED indicator will light green and the system will enter the recording mode.

#### Recording a radio module (DI-04):

- Enter the programming level №27;
  - Connect power supply of the module;
  - Press and hold the "VALET DI" button for 6 seconds. Release the button after the sixth flash of the "LED DI";
  - The system will confirm recording of the module to the system memory with 1 beep of the siren;
  - Press the VALET button to finish recording. The series of red and green flashes of the status LED will confirm saving.
- #### Recording a radio relay (BT-01)
- Enter the programming level №27;
  - Connect the wire 5 ("Ground") to a grounded spot of a car;
  - Apply +12V to the wire 1 (" +12V Power supply of the relay");
  - The system will confirm recording of the module to the system memory with 1 beep of the siren;
  - Press the VALET button to finish recording. The series of red and green flashes of the status LED will confirm saving.

### Levels №16/19/20/21/22/25/26/28 – Updating firmware of the built-in Bluetooth modem and additional Bluetooth devices

To update firmware of the built-in Bluetooth modem, enter the programming mode and enter the programming level №16. Open the Pandora BT application. Find your system in the mobile application, go to detected devices and select one of the updating option:

- File manager (for Android only) allows to upload the firmware from the phone storage;
- Internet option allows to upload firmware from the server to the base unit.

### Siren sound and turn indicators signals

Signal	Description
Alarm, PANIC mode	Incessant sound and light signals for 30 sec
Arming	1 sound and 1 light signals
Disarming	2 sound and 2 light signals
'Sensors triggered' signal when disarming	4 sound and 4 light signals
'Sensors malfunction' signal when arming	4 sound and 4 light signals
Warning level of a sensor is triggered	3 sound signals
Car search	5 sound and 5 light signals

### Beeper sound signals

Signal	Description
Enable the Service mode	1 sound signal
Disable the Service mode	2 sound signals
A battery in a radio tag is discharged	3 sound signals / 3 times
Absence of a radio tag	5 sound signals / 5 times
Blocking warning	Fast sound signals

## Meaning of the LED indicator colors

Indicator status	Description
Short red flashes	System is armed
Fast red flashes	Alarm
Fast green flashes	System is armed (a radio tag is in the coverage zone)
Lit red	The system is preparing for automatic arming
Orange flash	Confirms VALET button press
Orange flashes (when switching on the ignition)	Confirms the number of recorded remote controls
Green flashes (when switching on the ignition)	Confirms the number of recorded radio tags
Red flash	
(when switching on the ignition)	Confirms the recorded mobile device
Red and green flashes	PIN-code is confirmed
Faded	The system is disarmed

## Checking the number of recorded radio tags/mobile device

The number of recorded remote controls/radio tags/mobile device can be checked by the number of green and red flashes of the LED indicator. The number of recorded remote controls/tags/mobile device can be checked when switching on the ignition (the system must be disarmed). The number of green flashes will indicate the number of recorded radio tags, a following red flash will indicate a mobile device is recorded.

You can also check the number of recorded tags and registered mobile device by taking off and putting back on battery terminal. The system will emit short sound signals from a siren with less than 1 sec. interval. The number of the signals equals to the number of recorded radio tags. After a pause of 2 seconds the system signal will indicate registered mobile device.

## Addition devices

### Radio tag BT-760:

- Integrated 2.4 GHz radio interface (Bluetooth 4.2 Low Energy protocol)
- Built-in accelerometer
- Built-in control button
- Built-in LED
- CR 2032 battery



### Remote control D030

- OLED-display
- 3 control buttons
- Built-in sound indicator
- Built-in vibro-indicator
- Built-in LED indicator «ALARM/SEND»
- Integrated 2.4 GHz radio interface (Bluetooth 4.2 Low Energy protocol)
- Built-in battery
- Built-in micro-USB port



### Blocking radio relay BTR-101

Radio relay BTR-101 is an additional Bluetooth device designed to increase the system security features. The device has small dimensions and works with the system via a secure radio channel, which allows for concealed installation. The relay provides additional protection against mechanical and electronic hacking for a vehicle.

#### Main features:

Blocking controlled by the system and autonomous blocking in case of unauthorized movement.

#### Application and operating principle:

The power supply and circuit to be blocked are connected to the relay. The system control the relay via a radio channel.



### Radio module of engine compartment RHM-03 BT

This module is designed to simplify the system installation and wiring in the engine compartment module. The device has small dimensions and works with the system via a secure radio channel, which allows for concealed installation. The module provides additional protection against mechanical and electronic hacking for a vehicle.



#### Main features:

Blocking controlled by the system and autonomous blocking in case of unauthorized movement; controlling front hood locks, siren and digital control of Eberspaeher and Webasto engine preheaters; The module also sends the following information to the base unit: temperature, hood switch status, engine preheater status

#### Application and operating principle:

The module is installed discreetly in the engine compartment. It has a temperature sensor, built-in normally closed relay, "opening/closing hood lock" outputs, siren output, digital LIN output for an engine preheater, hood switch input.

### Door sensor DMS-100 BT

DMS-100 BT is an additional Bluetooth device designed to increase the system security features. The device has small dimensions and works with the system via a secure radio channel, which allows for concealed installation without additional power supply connections.

#### Main features:

The sensor sends the following information to the base unit: detection of shock and rotation, Hall effect sensor triggers, temperature.

#### Application and operating principle:

The sensor can be installed on wagon, trailer doors. It has its own power source.



### GPS/GLONASS receiver NAV-035 BT

NAV-035 BT – is an additional Bluetooth device designed to send location and time data to the base unit.

The device has small dimensions and works with the system via a secure radio channel, which allows placing it in any convenient location.



## System modules layout

Ask an installer to mark system's modules on the picture provided. This information can be important for diagnostics in case system malfunctions.

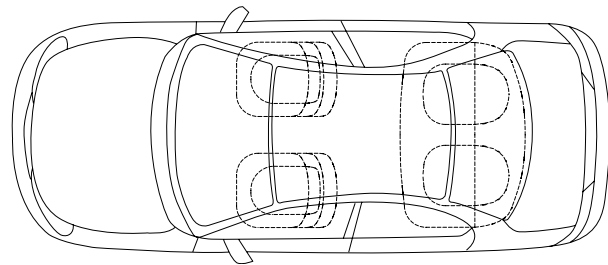
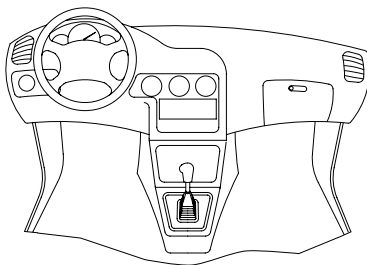

## WARRANTY OBLIGATIONS

**WARNING! WE RECOMMEND YOU TO ASK AN INSTALLER TO FILL OUT THE INSTALLATION CERTIFICATE AND THE WARRANTY CARD. THESE DOCUMENTS MAY BE REQUIRED FOR CONTACTING THE CUSTOMER SUPPORT**

Manufacturer guarantees correct operation of the service-security system if exploitation, installation, storage and transportation conditions described in this manual were met.

The system should only be used according to installation scheme and user manuals.

The system is meant to be installed by the professional car electronics installers. The installer should fill in installation certificate that is included in this manual. Parts malfunctioning during warranty period on the fault of the manufacturer should be repaired or replaced by the installation center of the manufacturer or by certified service center. List of certified service centers can be found on [pandorainfo.com](http://pandorainfo.com)

The user loses the right for warranty services in the following cases:

- when warranty period expires;
- if exploitation, installation, storage or transportation conditions were not met;
- if there is mechanical damage of the external parts of the system after it is sold.

This includes: fire damage, consequential damage in case of car accident, aggressive liquids and water seeping damage, damage caused by improper use;

- if the damage was caused with incorrect settings and parameter adjustment;
- if system devices are replaced with any devices that are not recommended by the manufacturer;
- if manufacturer sealing is broken;
- if there is no properly filled warranty card and installation certificate.

Warranty period is 3 years since the moment of purchase, but no more than 3,5 (three and a half ) years since the moment of production. This warranty does not include batteries of the remotes, as they have their own service lifetime.

Maintenances and repairs of the system with expired warranty period are carried out at the expense of the user on a separate contract between the user and the installer/service center.

## Installation certificate

I, the undersigned \_\_\_\_\_

Position, name

professional installer, certify, installation of the service-security system, described below was carried out by me according to manuals and schemes provided by the manufacturer.

### Car specifications:

Car model \_\_\_\_\_

Type \_\_\_\_\_

ID number (VIN) \_\_\_\_\_

Registration number \_\_\_\_\_

### Security system specifications:

Model PANDORA DXL 0110L V2

Serial number \_\_\_\_\_

Service center name, full address and installer's stamp \_\_\_\_\_

Signature \_\_\_\_\_ / \_\_\_\_\_ /

Signator

Work accepted \_\_\_\_\_ / \_\_\_\_\_ /

Signator

Date " \_\_\_\_ " \_\_\_\_\_ 20\_\_y

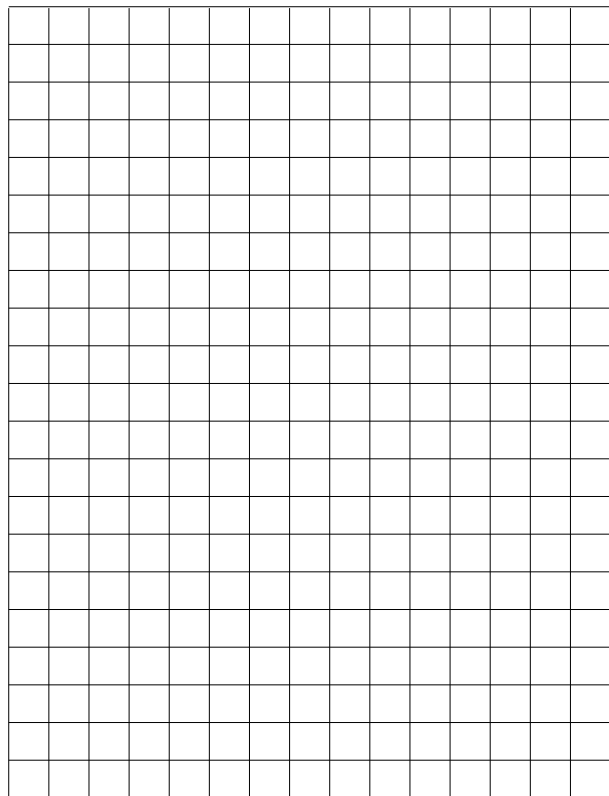
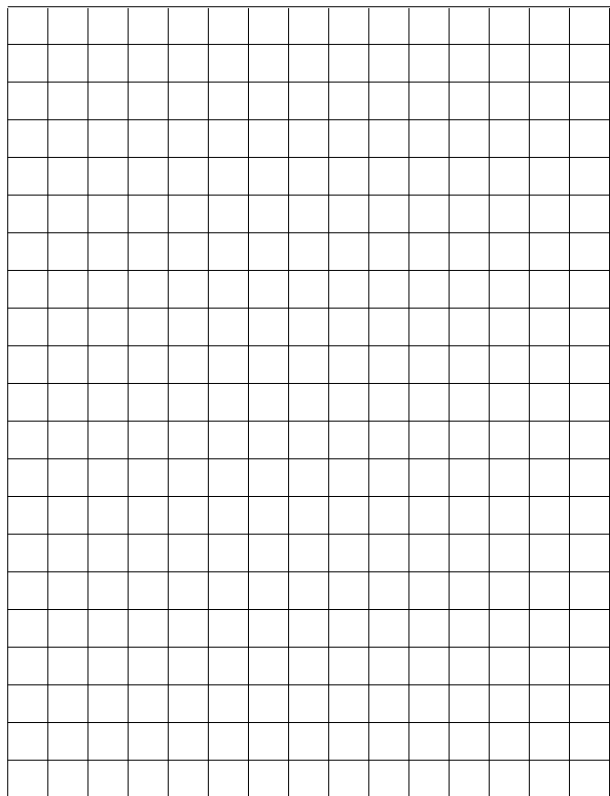

## Acceptance certificate

**Pandora Pandora Mini v2** is in conformity with Electromagnetic Compatibility Directive EMC 2004/108/EC and R&TTE Directive 1999/5/EC.

Serial number \_\_\_\_\_

Date of production \_\_\_\_\_

Responsible person's signature \_\_\_\_\_

(stamp)

Packager \_\_\_\_\_

Signature (personal stamp)

---

## Warranty card

Model **Pandora Pandora Mini v2**

Serial number \_\_\_\_\_

Date of purchase « \_\_\_\_ » \_\_\_\_\_ 20\_\_ year

\_\_\_\_\_  
Seller's (installer's) stamp

Seller's signature \_\_\_\_\_